

# Fixed Attenuator

## Model FA40-0203-KMKF Rev.A

DC-40GHz 2.92mm Fixed Attenuator; 3dB; 2W;

Micable FA40-0203-KMKF is a DC-40GHz fixed attenuator, it has excellent attenuation accuracy and VSWR. It's finished with passivated stainless steel body, and has rugged configuration and long life of use. It is ideal for the wideband system precision attenuation control, test and improvement of matching.



### Specifications

All specifications are subject to change without notice at any time

Frequency Range	GHz	DC-18	18-26.5	26.5-40
VSWR	:1(Max.)	1.25	1.3	1.35
Attenuation	dB(Typ.)	3	3	3
Attenuation Accuracy	dB(Max.)	-0.8~+0.8	-0.8~+0.8	-0.8~+1.0
Impedance	50Ω			
Power	≤2W			
Durability	≥500 Cycles			
Weight	≤5g			
Dimension <sup>1</sup>	Φ9.0x22.4 (mm)			
Interface	2.92mm [M] - 2.92mm [F]			
Outer Conductor	Stainless steel, passivated			
Center Conductor	BeCu / Brass, gold plating			
Dielectric	PEI			
Temperature	Operating: -55~+125°C			

Note 1. Unless otherwise specified, Decimal tolerance: x.±0.3

### Outline Drawing

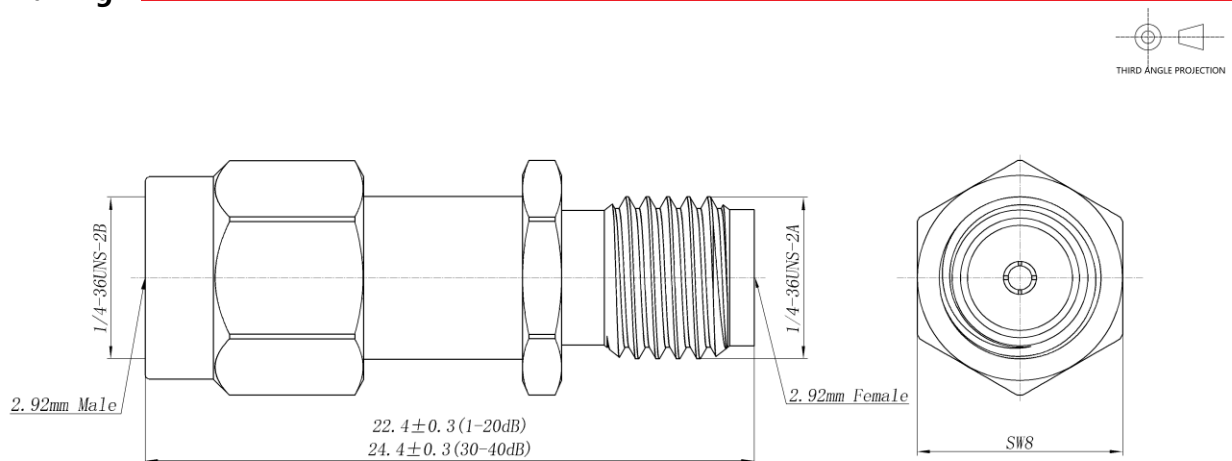

# Fixed Attenuator

## Model FA40-0203-KMKF Rev.A

DC-40GHz 2.92mm Fixed Attenuator; 3dB; 2W;

### Typical Graph

@Ambient Temperature

