

Fixed Attenuator

Model FA18-0206-PMF Rev.A

DC-18GHz SMP Fixed Attenuator; 6dB; 2W;



Micable FA18-0206-PMF is a DC-18GHz fixed attenuator, it has excellent attenuation accuracy and VSWR. It's finished with passivated stainless steel body, and has rugged configuration and long life of use. It is ideal for the wideband system precision attenuation control, test and improvement of matching.

Specifications

All specifications are subject to change without notice at any time

Frequency Range	GHz	DC-8	8-12.4	12.4-18
VSWR	:1(Max.)	1.25	1.3	1.35
Attenuation	dB(Typ.)	6	6	6
Attenuation Accuracy	dB(Max.)	-0.5~+0.5	-0.5~+0.5	-0.5~+0.5
Impedance	50Ω			
Power	≤2W			
Durability	≥500 Cycles			
Weight	≤6g			
Dimension ¹	Φ6.5x20.0 (mm)			
Interface	SMP [M] - SMP [F]			
Outer Conductor	Stainless steel, passivated/BeCu, gold plating			
Center Conductor	BeCu, gold plating			
Dielectric	PTFE			
Temperature	Operating: -55~+125°C			

Note 1. Unless otherwise specified, Decimal tolerance: x.±0.3

Outline Drawing

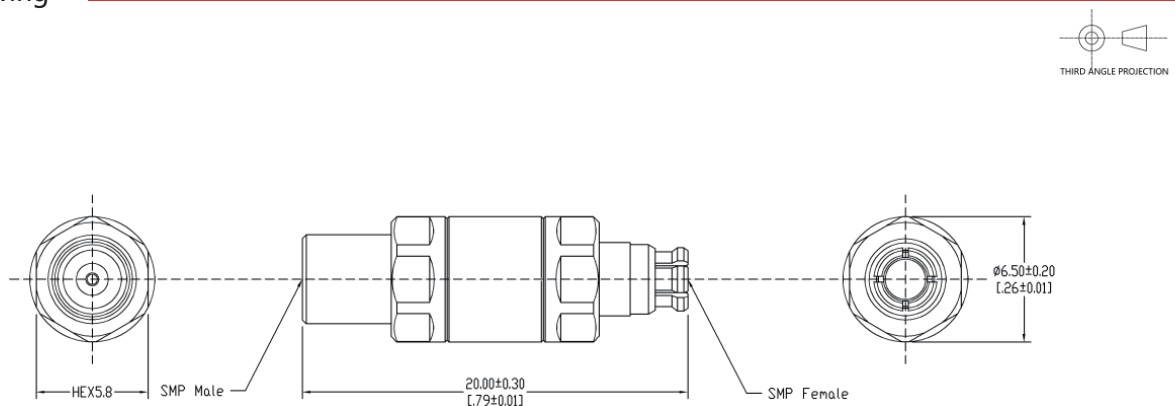

Fixed Attenuator

Model FA18-0206-PMF Rev.A

DC-18GHz SMP Fixed Attenuator; 6dB; 2W;

Typical Graph

Typical test environment: 25°C and 60%RH

