

50Ω Adapters 3.5mm Male - 3.5mm Male 90° Right Angle

Part Number: 35-MMW

Electrical Specifications at 25°C, all specifications are subject to change without notice at any time. Rev. A

Frequency Range	DC-33GHz
VSWR (Max.)	1.30:1
Insertion Loss (Max.)	0.7dB
Durability (Min.)	1000 Cycles
Insulation Resistance (Min.)	5000 MΩ
Operating Temperature	-65°C ~ +165°C
Body Material	Stainless Steel Passivated
Center Conductor	Brass&Beryllium Copper Gold Plated
Dielectric	PEI&PTFE

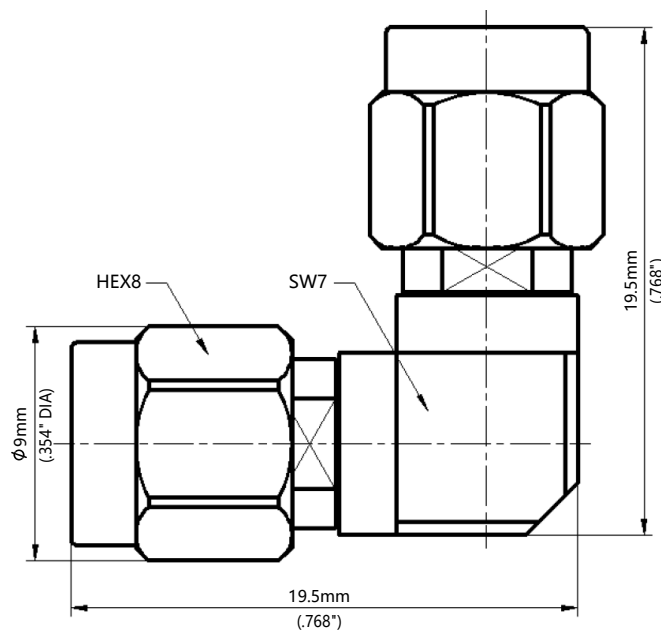

50Ω Adapters 3.5mm Male - 3.5mm Male 90° Right Angle

Part Number: 35-MMW

Electrical Specifications at 25°C, all specifications are subject to change without notice at any time. Rev. A



Typical Graph

