

50Ω Adapters 2.4mm Male - 2.4mm Female

Part Number: 24-MF



Electrical Specifications at 25°C, all specifications are subject to change without notice at any time. Rev. A

Frequency Range	DC-50GHz
VSWR (Max.)	1.15:1
Insertion Loss (Max.)	0.35dB
Durability (Min.)	1000 Cycles
Insulation Resistance (Min.)	3000 MΩ
Operating Temperature	-65°C ~ +165°C
Body Material	Stainless Steel Passivated
Center Conductor	Beryllium Copper Gold Plated
Dielectric	PEI

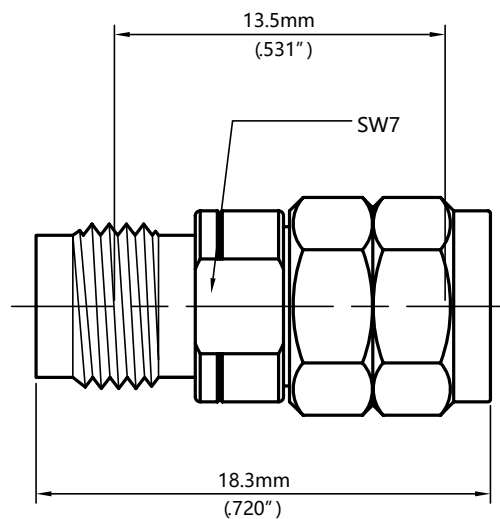

Electrical & Mechanical Specifications

2D Outline Drawing

50Ω Adapters 2.4mm Male - 2.4mm Female

Part Number: 24-MF



Electrical Specifications at 25°C, all specifications are subject to change without notice at any time. Rev. A

